

Brick**Nerd** Instructions

Tinkerbell



Design by Miro Dudas

To celebrate the magical theme of this issue, we decided to create a life-size Tinker Bell. The core design repurposes my previous Surfing Girls creation from a few years ago. The arms and legs were already positioned perfectly so adjusting them for Tink was a breeze. All I had to do was make her fly.

I gave her a pedestal and a clear support to anchor her in mid-air. (Building tip: use an older clear support rod since they are more rigid. The newer ones are made with a newer plastic that has a bit more bend and can't quite support the fairy.) The model wobbles slightly when moved so it almost looks like she is hovering all on her own.

The wings were a challenge but I stuck to a simple and sturdy design to let the colors shine and sparkle. And finally, you can easily swap all the tan pieces for reddish brown to make any version of Tinker Bell you wish. So grab some pixie dust and start building on your way to Never Never Land!

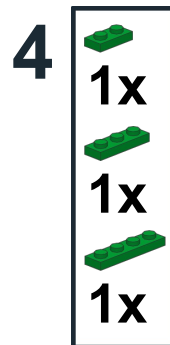
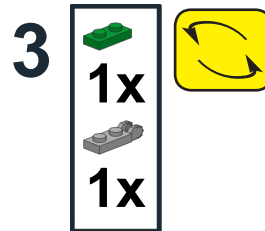
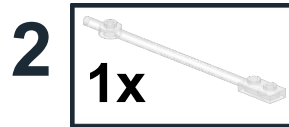
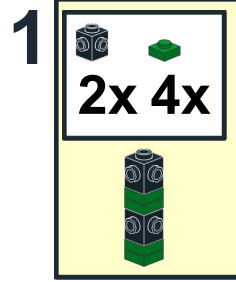

5

1x
1x



6

1x
1x

7

1x
1x



8

1x
1x

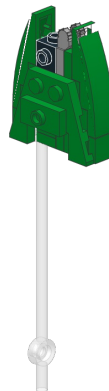

9

1x
1x





10

1			1x 1x
2			1x 1x
3			1x 1x
4			1x 1x
5			1x 1x

11

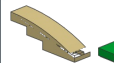

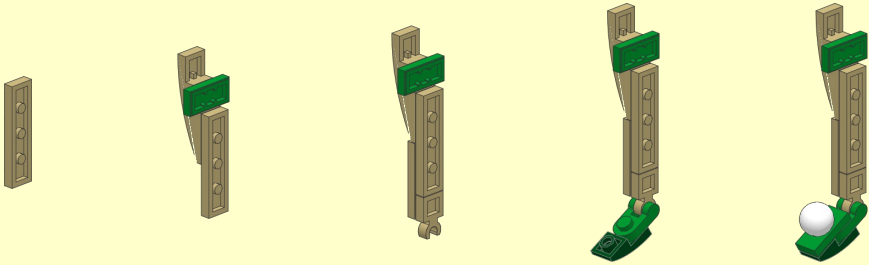
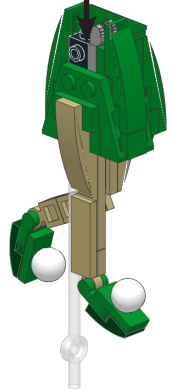

1			1x 1x
2		1x	
3		2x	
4		1x	

12

1 1x 	2 1x 1x 	3 1x 1x 	4 1x 1x 	5 1x 1x 
--	---	---	---	---







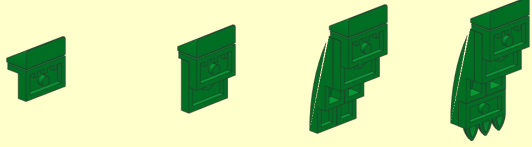
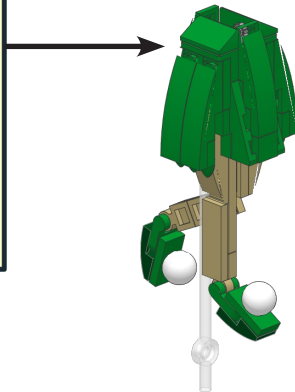

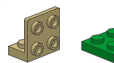

13

1 1x 1x 	2 1x 	3 2x 	4 1x 
---	--	--	--

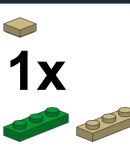

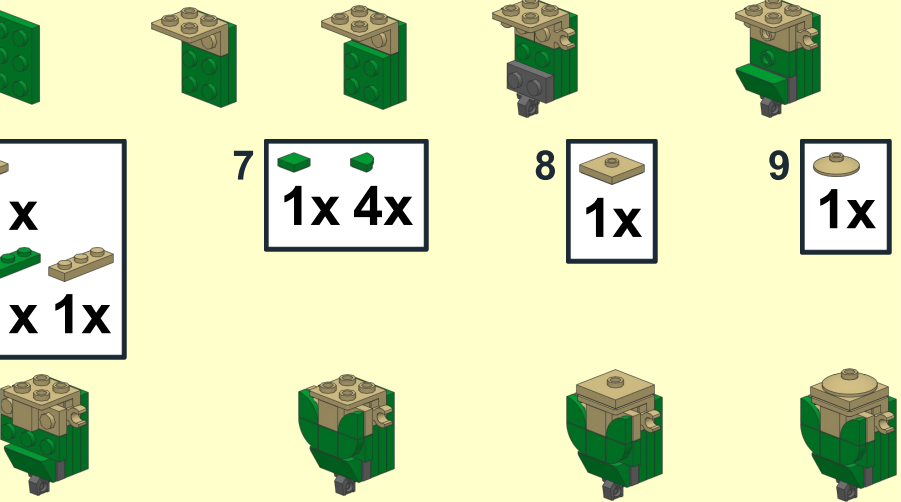
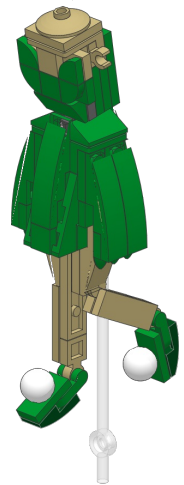

14

1 1x 	2 1x 1x 	3 1x 	4 1x 2x 	5 1x 1x 1x 
6 1x 1x 1x 	7 1x 4x 	8 1x 	9 1x 	

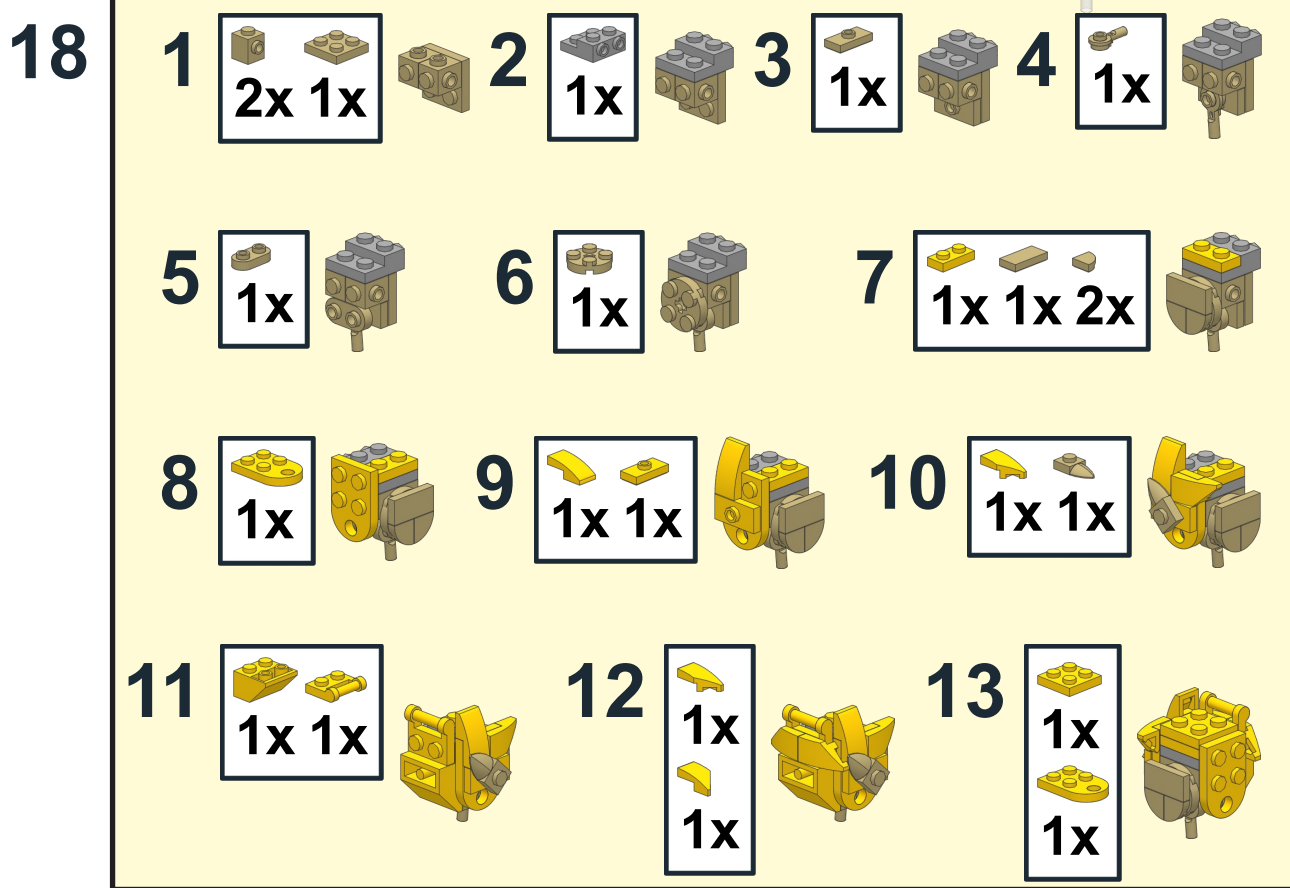
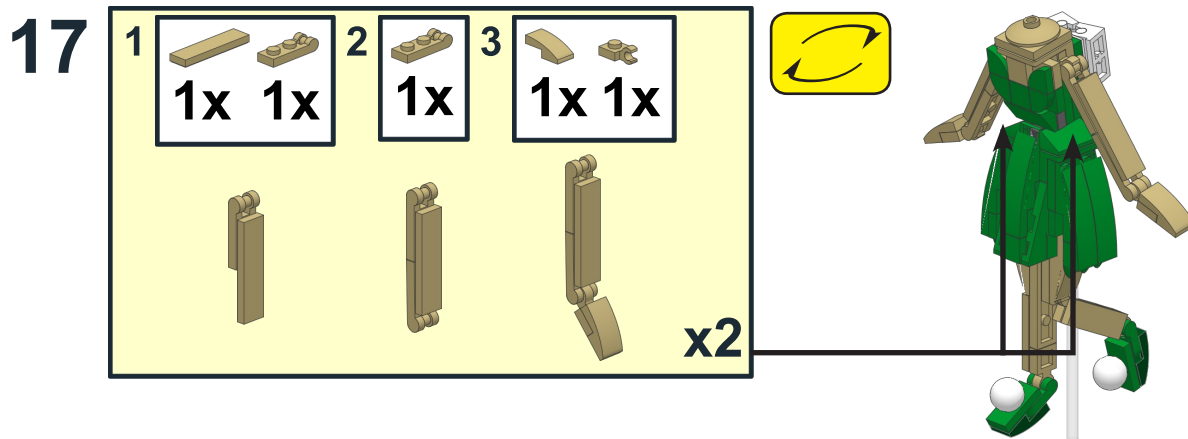
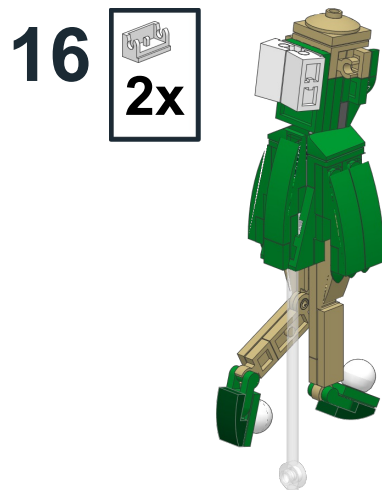
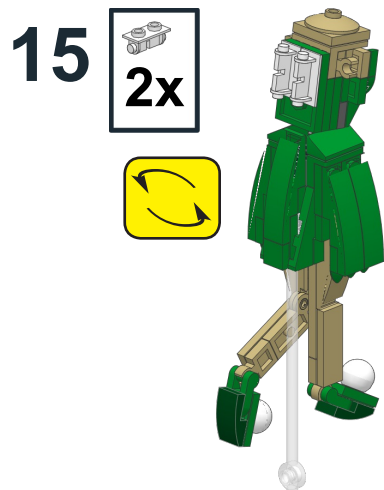

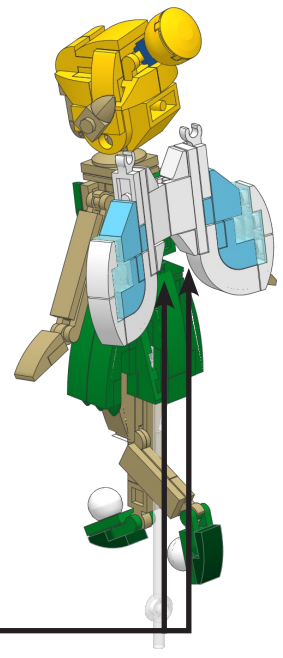
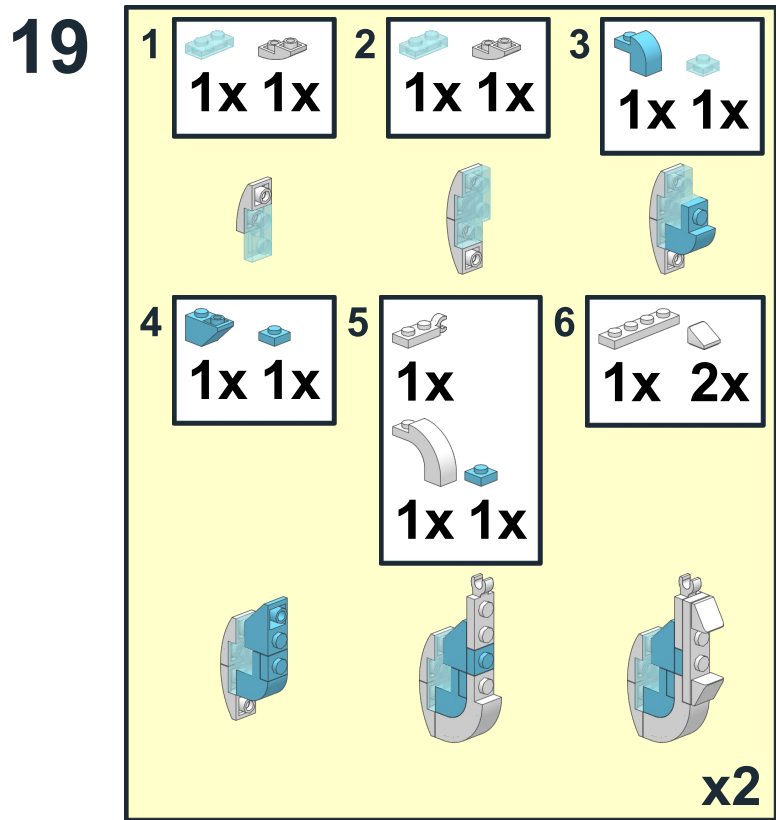
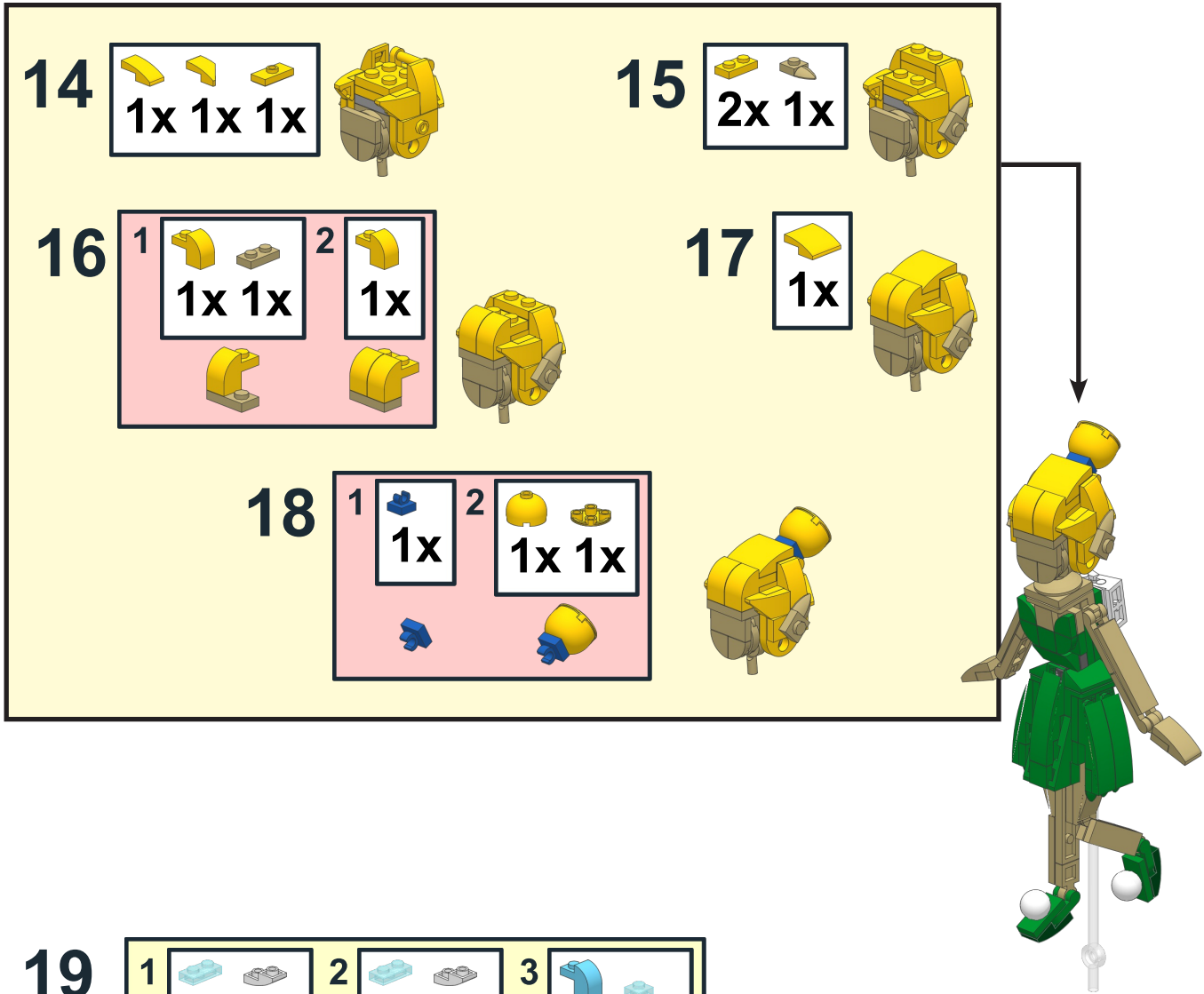

20

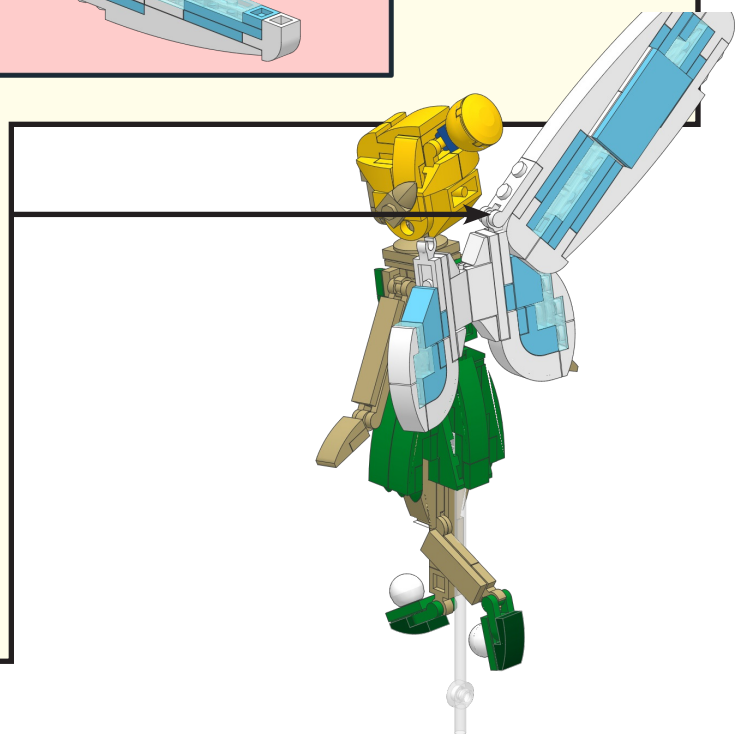
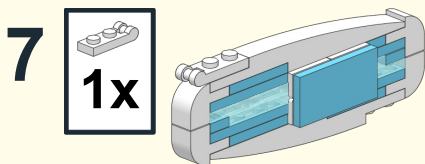
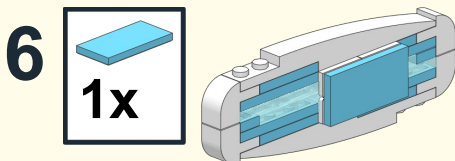
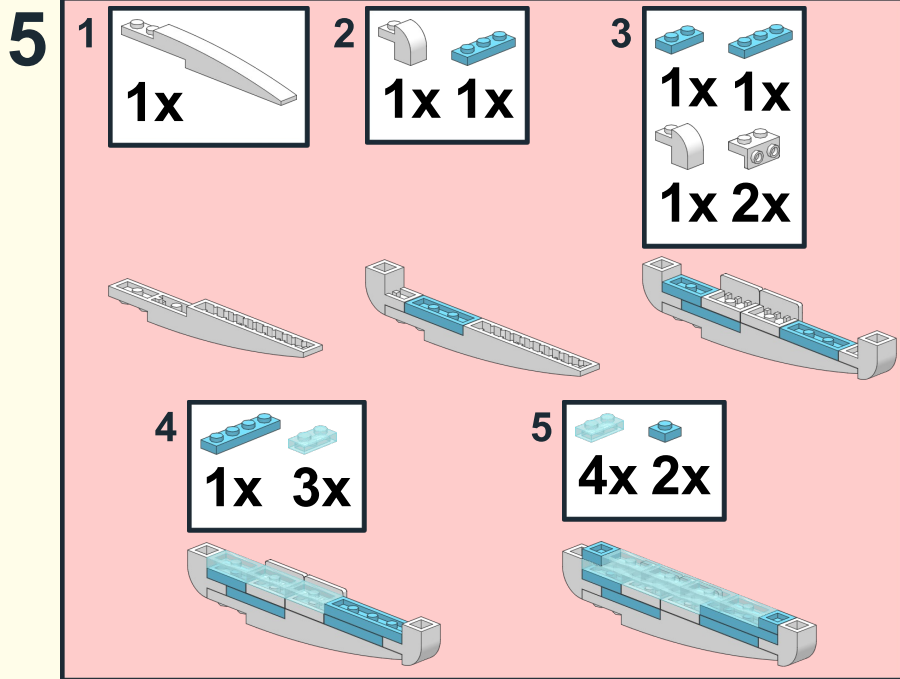
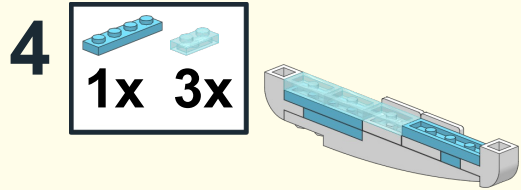
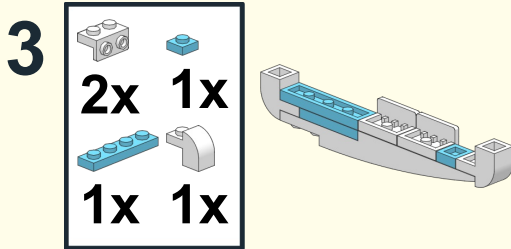
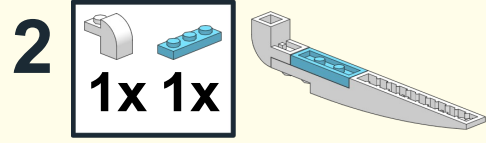
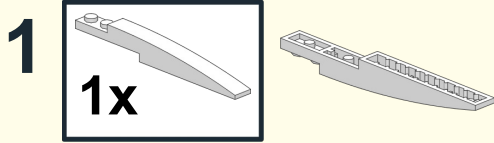

21

1

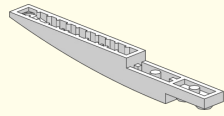
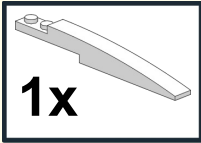

2

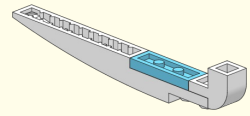
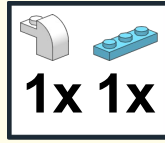

3

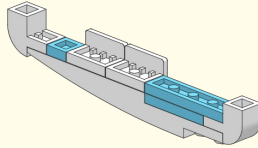
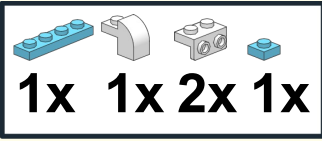

4

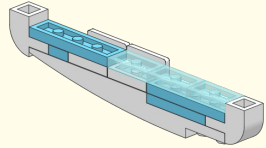
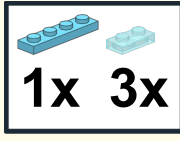

5

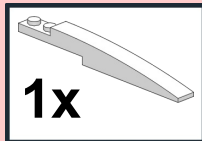
1  1x

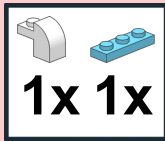
2  1x 1x

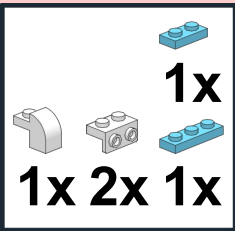
3  1x 1x 2x 1x

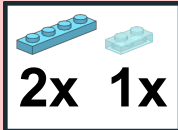
4  2x 1x

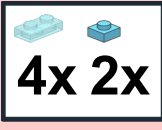
5  4x 2x

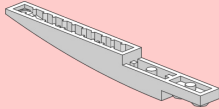
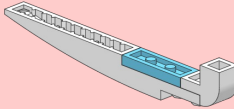
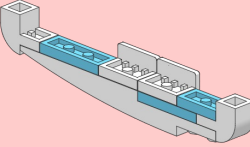
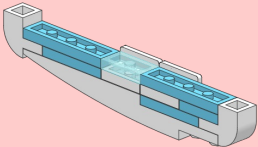
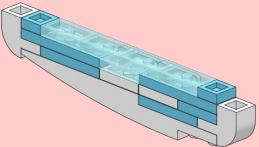
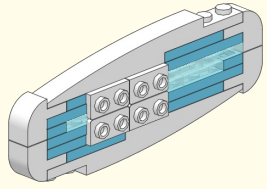
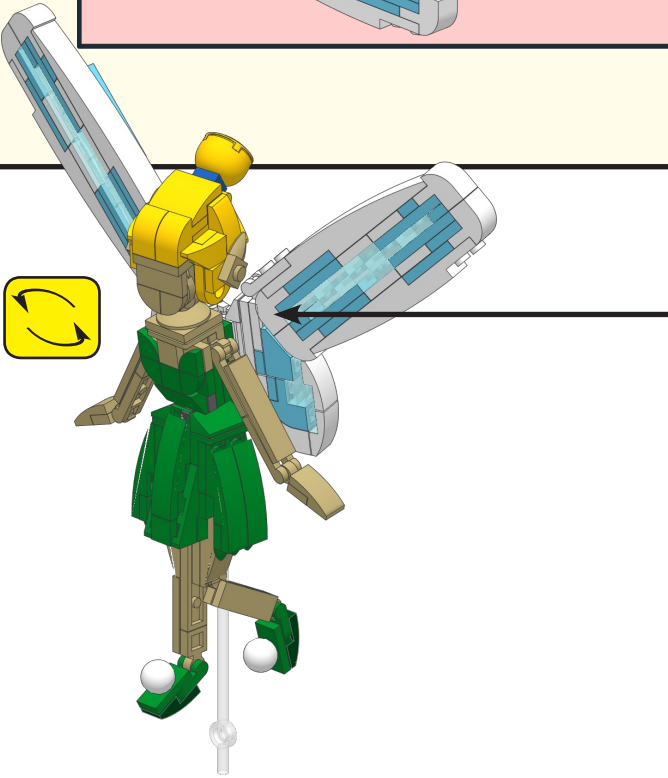
6



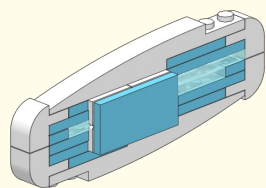
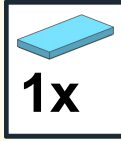

7

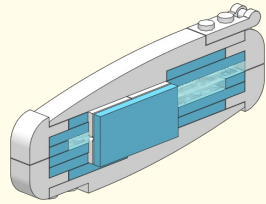
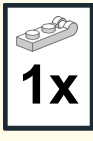

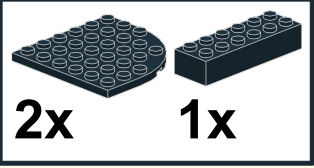
22

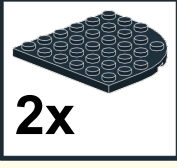
1  2x 1x

2  2x

3  2x

4  4x

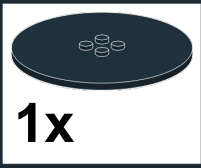
5  1x

6  1x



Parts List

(Parts can be ordered through Bricklink.com by searching by part number and color)

Qty	Part	Color	Description
1	15712.dat	Blue	Tile 1 x 1 with Clip (Thick C-Clip)
1	2456.dat	Black	Brick 2 x 6
2	3003.dat	Black	Brick 2 x 2
1	3942c.dat	Black	Cone 2 x 2 x 2 with Hollow Stud Open
2	4733.dat	Black	Brick 1 x 1 with Studs on Four Sides
4	6003.dat	Black	Plate 6 x 6 with Round Corner
1	6177.dat	Black	Plate 8 x 8 Round with 2 x 2 Centre Studs
4	95188.dat	Black	Brick 6 x 6 Corner Round with Slope 33 Chamfer
2	3023.dat	Medium Azure	Plate 1 x 2
10	3024.dat	Medium Azure	Plate 1 x 1
6	3623.dat	Medium Azure	Plate 1 x 3
2	3665a.dat	Medium Azure	Slope Brick 45 2 x 1 Inverted without Inner Stopper Ring
7	3710.dat	Medium Azure	Plate 1 x 4
2	6091.dat	Medium Azure	Brick 2 x 1 x 1.333 with Curved Top
2	87079.dat	Medium Azure	Tile 2 x 4 with Groove
22	3023.dat	Trans Light Blue	Plate 1 x 2
2	3024.dat	Trans Light Blue	Plate 1 x 1
2	24201.dat	Dark Green	Slope Brick Curved 2 x 1 Inverted
1	3021.dat	Green	Plate 2 x 3
4	3022.dat	Green	Plate 2 x 2
3	3023.dat	Green	Plate 1 x 2
5	3024.dat	Green	Plate 1 x 1
3	3070b.dat	Green	Tile 1 x 1 with Groove
2	3623.dat	Green	Plate 1 x 3
1	3710.dat	Green	Plate 1 x 4
2	15208.dat	Green	Plate 1 x 2 with 3 Teeth In-line
7	15573.dat	Green	Plate 1 x 2 with Groove with 1 Centre Stud, without Understud
4	25269.dat	Green	Tile 1 x 1 Corner Round
2	26047.dat	Green	Plate 1 x 1 Round with Horizontal Handle on Side
2	48183.dat	Green	Wing 3 x 4 with 1 x 2 Cutout with Stud Notches
6	61678.dat	Green	Slope Brick Curved 4 x 1
3	85984.dat	Green	Slope Brick 31 1 x 2 x 0.667
2	99780.dat	Green	Bracket 1 x 2 - 1 x 2 Up
1	2654a.dat	Yellow	Dish 2 x 2 with Rim
1	3022.dat	Yellow	Plate 2 x 2
3	3023.dat	Yellow	Plate 1 x 2
2	3176.dat	Yellow	Plate 3 x 2 with Hole
1	3660a.dat	Yellow	Slope Brick 45 2 x 2 Inverted without Inner Stopper Ring
2	6091.dat	Yellow	Brick 2 x 1 x 1.333 with Curved Top
2	11477.dat	Yellow	Slope Brick Curved 2 x 1
1	15068.dat	Yellow	Slope Brick Curved 2 x 2 x 0.667
2	15573.dat	Yellow	Plate 1 x 2 with Groove with 1 Centre Stud, without Understud
2	29119.dat	Yellow	Slope Brick Curved 2 x 1 with Cutout Right
2	29120.dat	Yellow	Slope Brick Curved 2 x 1 with Cutout Left
1	30367c.dat	Yellow	Cylinder 2 x 2 with Dome Top with Axle Hole and Hollow Stud

Qty	Part	Color	Description
1	48336.dat	Yellow	Plate 1 x 2 with Handle Type 2
1	2429.dat	Tan	Hinge Plate 1 x 4 Base
1	2430.dat	Tan	Hinge Plate 1 x 4 Top
2	2431.dat	Tan	Tile 1 x 4 with Groove
1	3022.dat	Tan	Plate 2 x 2
1	3023.dat	Tan	Plate 1 x 2
1	3069b.dat	Tan	Tile 1 x 2 with Groove
1	3070b.dat	Tan	Tile 1 x 1 with Groove
1	3623.dat	Tan	Plate 1 x 3
1	3710.dat	Tan	Plate 1 x 4
1	4032a.dat	Tan	Plate 2 x 2 Round with Axlehole
1	4740.dat	Tan	Dish 2 x 2 Inverted
2	11477.dat	Tan	Slope Brick Curved 2 x 1
2	15573.dat	Tan	Plate 1 x 2 with Groove with 1 Centre Stud, without Understud
2	25269.dat	Tan	Tile 1 x 1 Corner Round
2	26604.dat	Tan	Brick 1 x 1 with Studs on Two Adjacent Sides
1	32828.dat	Tan	Plate 1 x 1 Round with Bar
1	35480.dat	Tan	Plate 1 x 2 with Round Ends and 2 Open Studs
2	49668.dat	Tan	Plate 1 x 1 with Tooth In-line
4	60478.dat	Tan	Plate 1 x 2 with Handle on End
4	60897.dat	Tan	Plate 1 x 1 with Clip Vertical (Thick C-Clip)
2	61252.dat	Tan	Plate 1 x 1 with Clip Horizontal (Thick C-Clip)
2	61678.dat	Tan	Slope Brick Curved 4 x 1
2	63864.dat	Tan	Tile 1 x 3
1	87580.dat	Tan	Plate 2 x 2 with Groove with 1 Centre Stud
1	99207.dat	Tan	Bracket 1 x 2 - 2 x 2 Up
1	99784.dat	Trans Clear	Bar 12L with Plate 1 x 2 with Hollow Studs and Hollow Stud
2	3710.dat	White	Plate 1 x 4
2	3937.dat	White	Hinge 1 x 2 Base
2	3938.dat	White	Hinge 1 x 2 Top
2	6005.dat	White	Arch 1 x 3 x 2 with Curved Top
8	6091.dat	White	Brick 2 x 1 x 1.333 with Curved Top
4	24201.dat	White	Slope Brick Curved 2 x 1 Inverted
2	32474.dat	White	Technic Ball Joint White with Axlehole Blind
4	54200.dat	White	Slope Brick 31 1 x 1 x 0.667
2	60478.dat	White	Plate 1 x 2 with Handle on End
2	63868.dat	White	Plate 1 x 2 with Clip Horizontal on End (Thick C-Clip)
4	85970.dat	White	Slope Brick Curved 1 x 8 with Plate 1 x 2
8	99781.dat	White	Bracket 1 x 2 - 1 x 2 Down
1	54657.dat	Lt Bluish Grey	Hinge Plate 1 x 2 Locking with Dual Finger on End Vertical, 7 Teeth
1	99206.dat	Lt Bluish Grey	Plate 2 x 2 x 0.667 with Two Studs On Side and Two Raised
1	44567b.dat	Dk Bluish Grey	Hinge Plate 1 x 2 Locking without Groove with Single Finger On Side Vertical