

Instructions to Build a Mini Upscaled
LEGO TREASURE CHEST

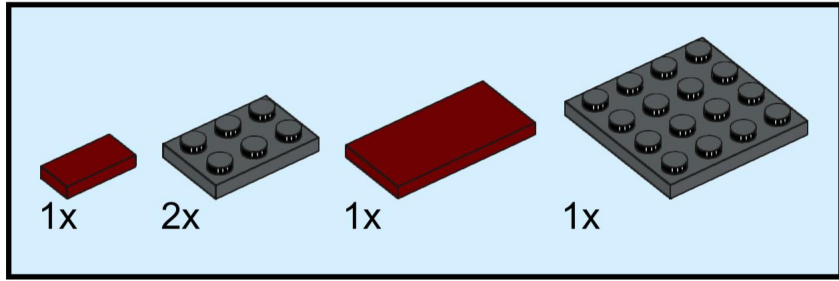

Designed for BrickNerd by
SEAN MAYO

1



2

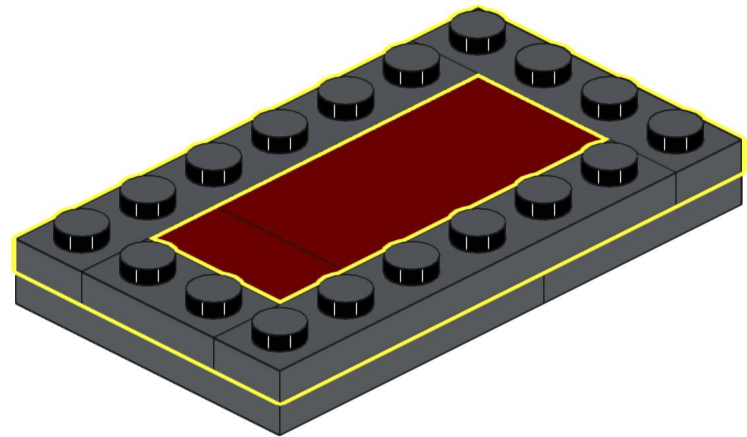
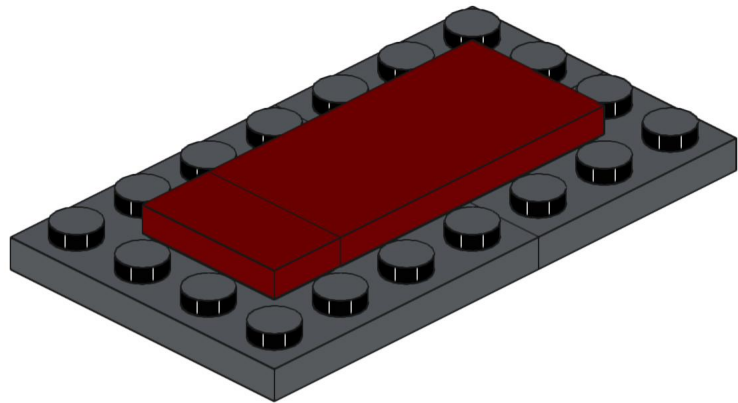
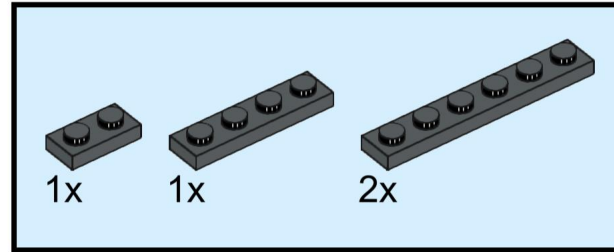

3

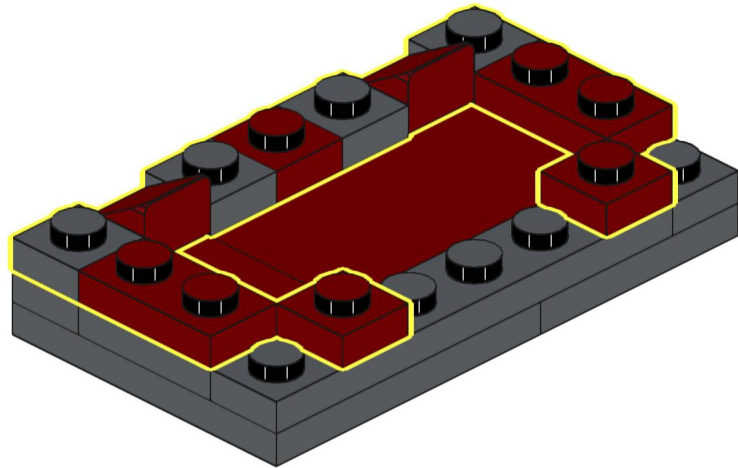
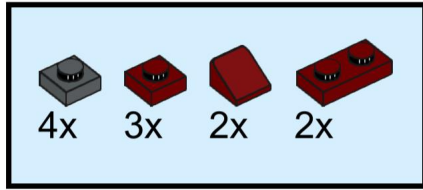

4

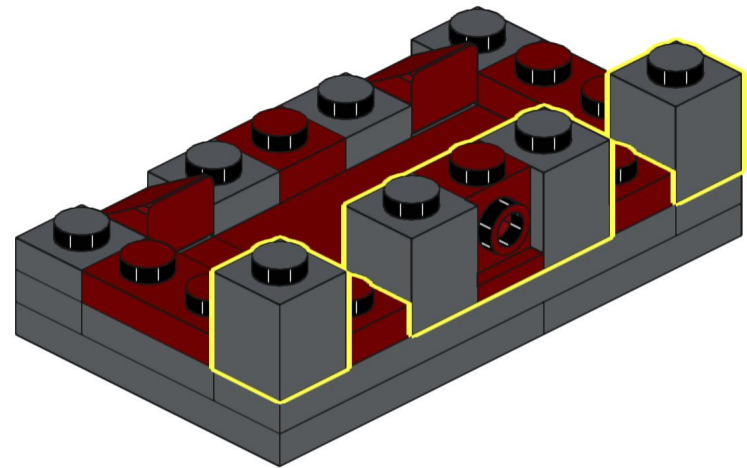
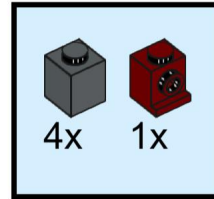

5

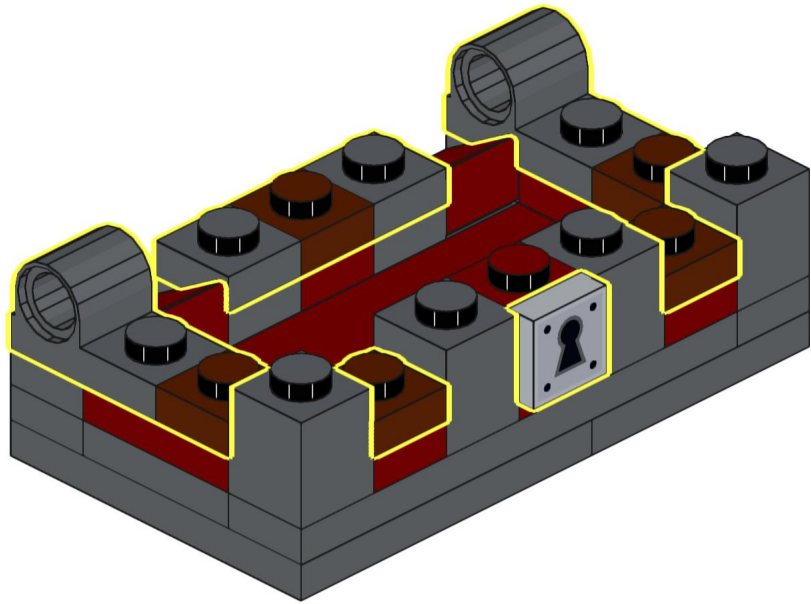
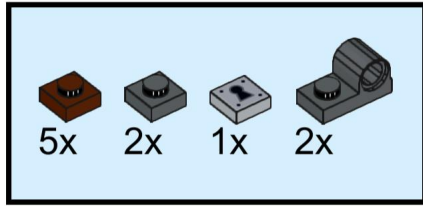

6

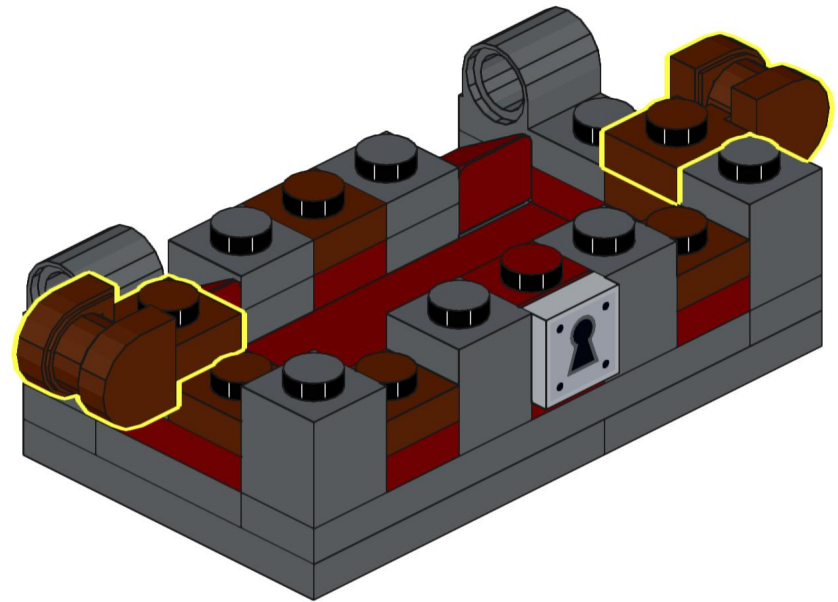
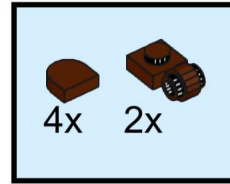

7

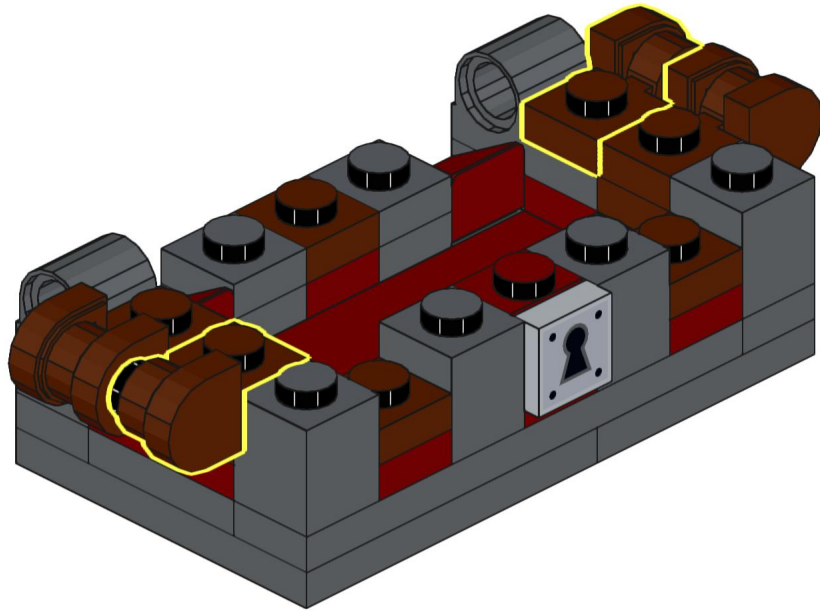
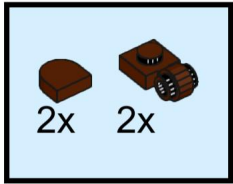

8

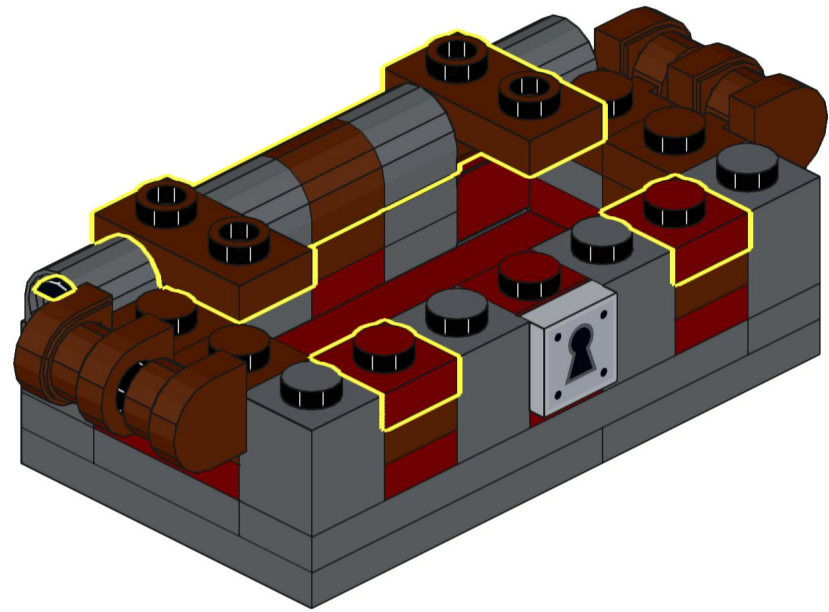
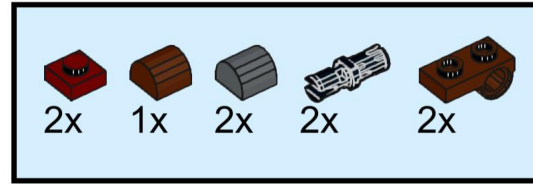

9

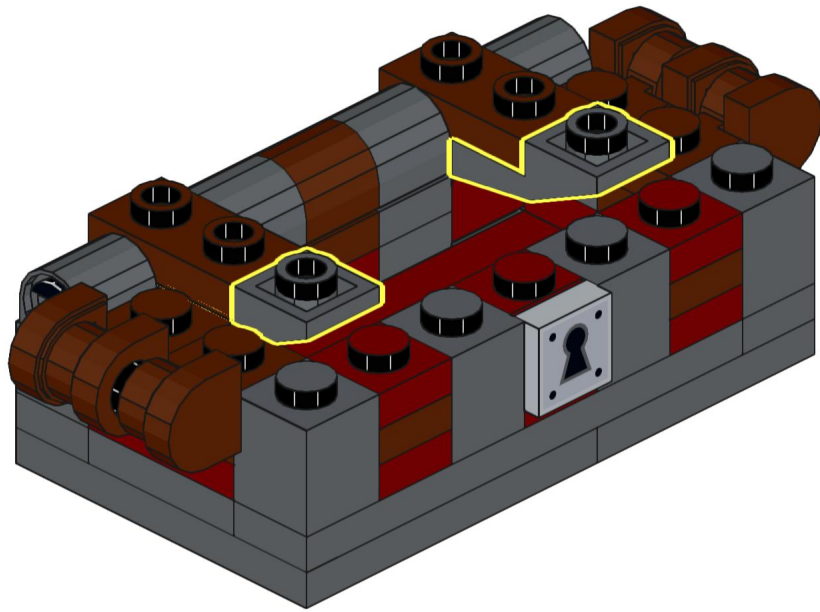
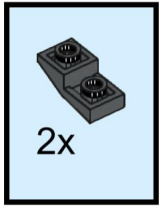

10

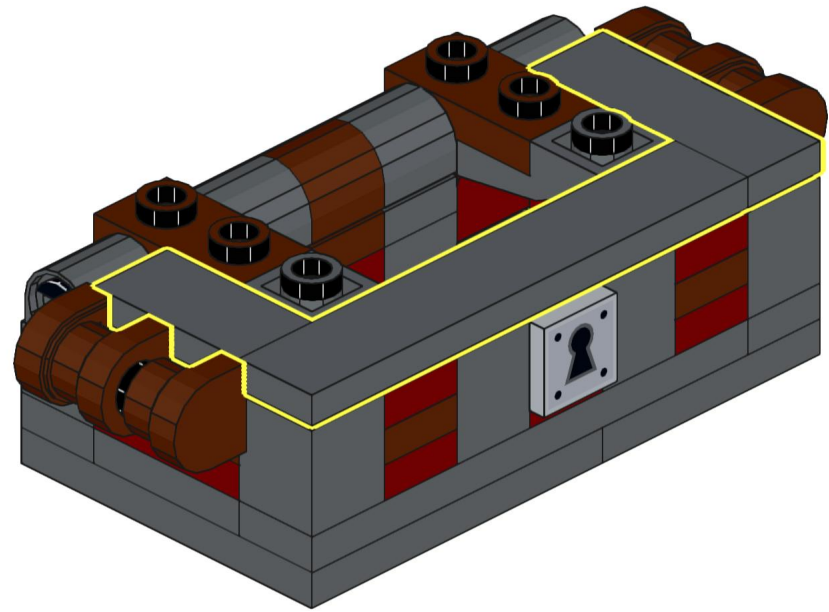
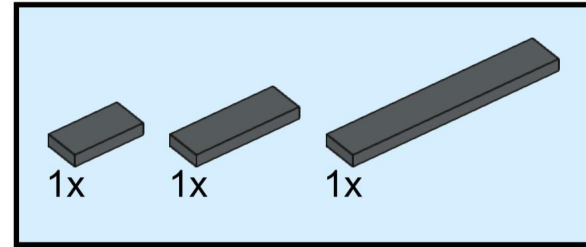

11

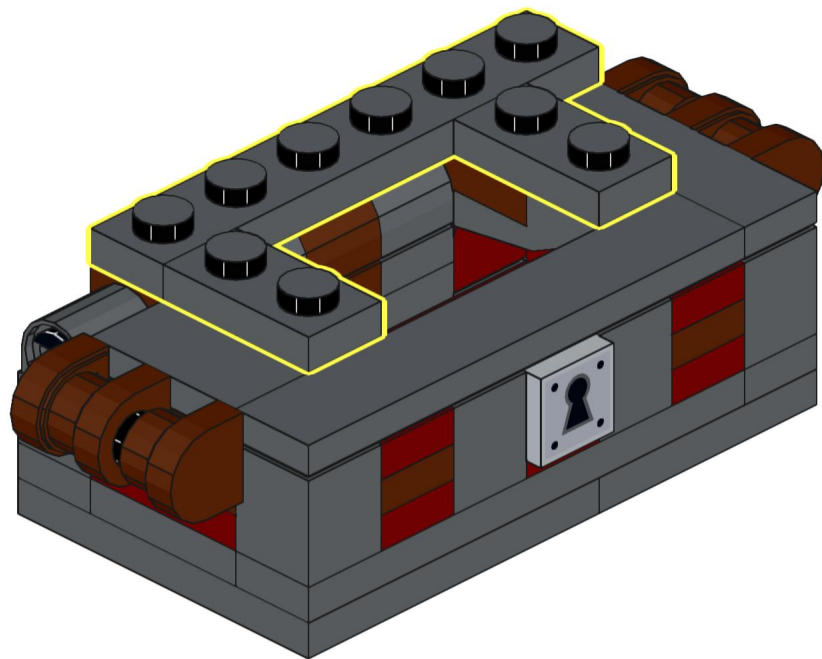
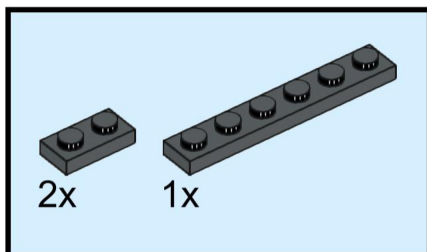

12

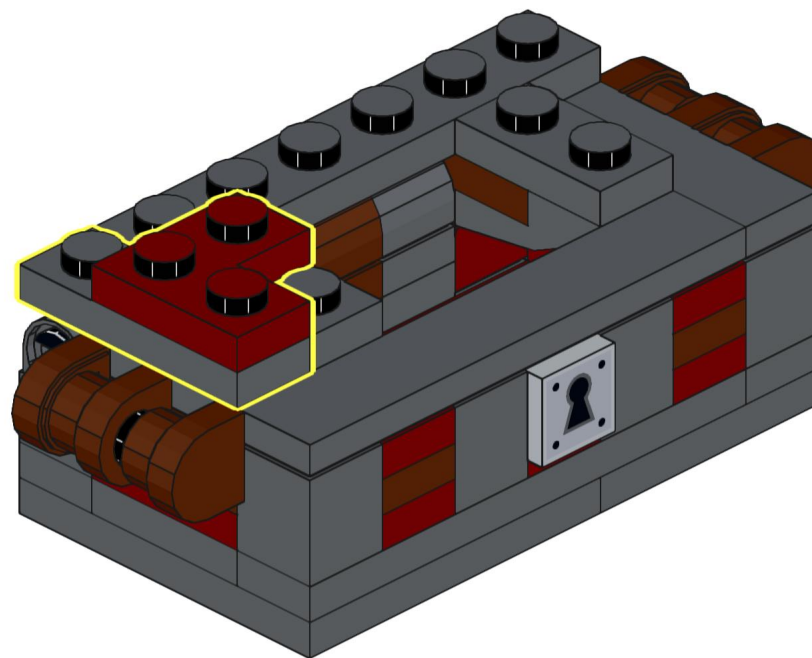
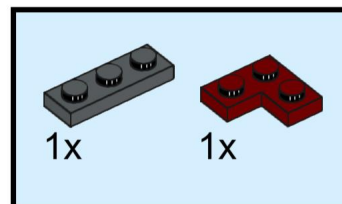

15

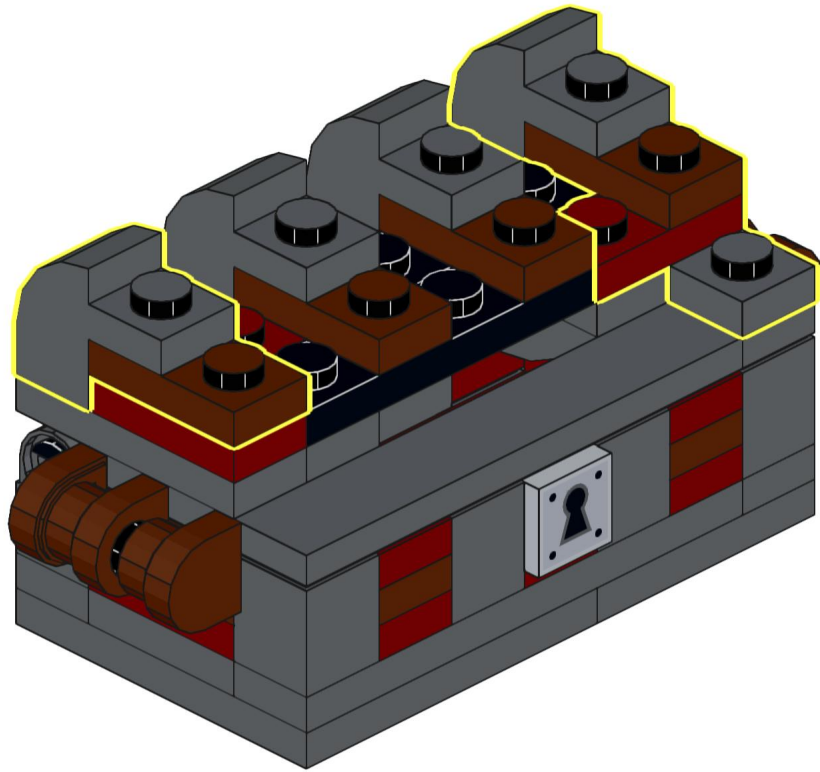
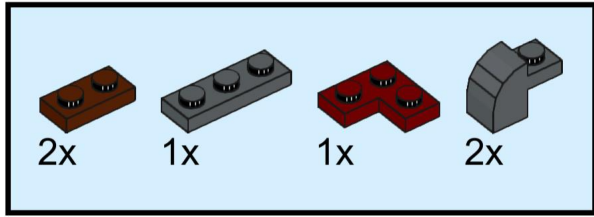

16

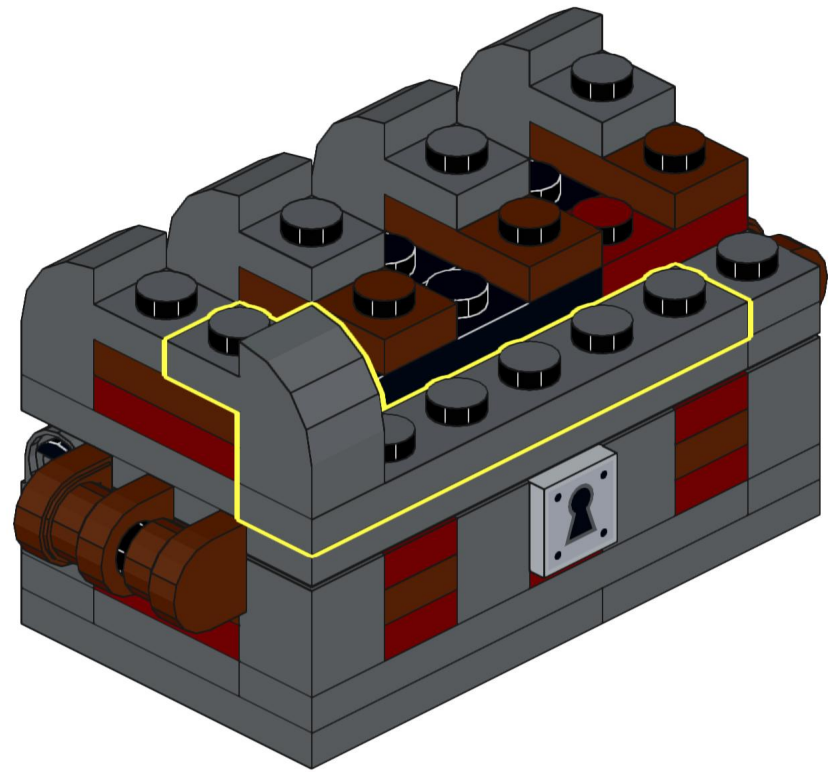
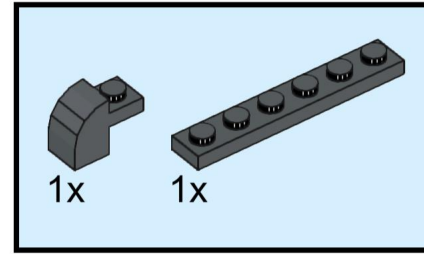

17

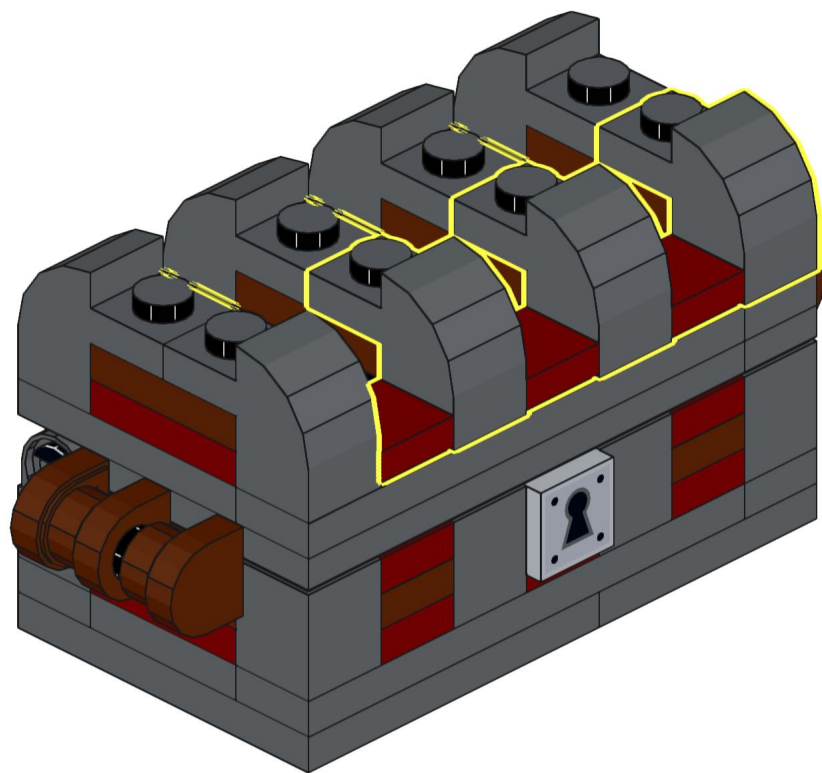
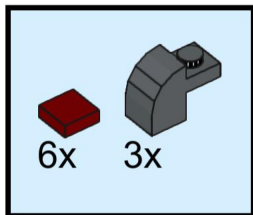

18

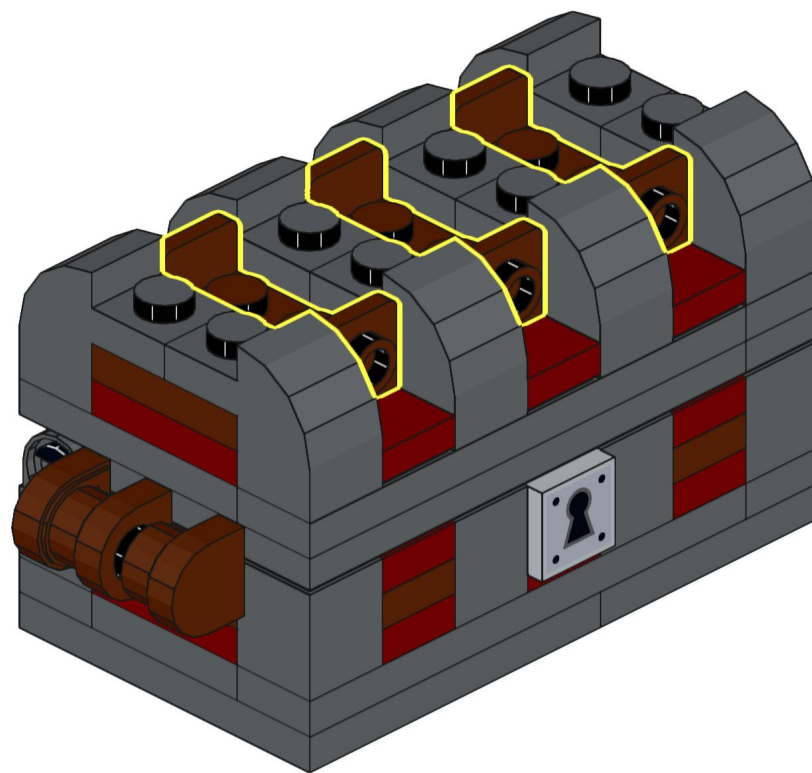
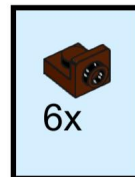

19

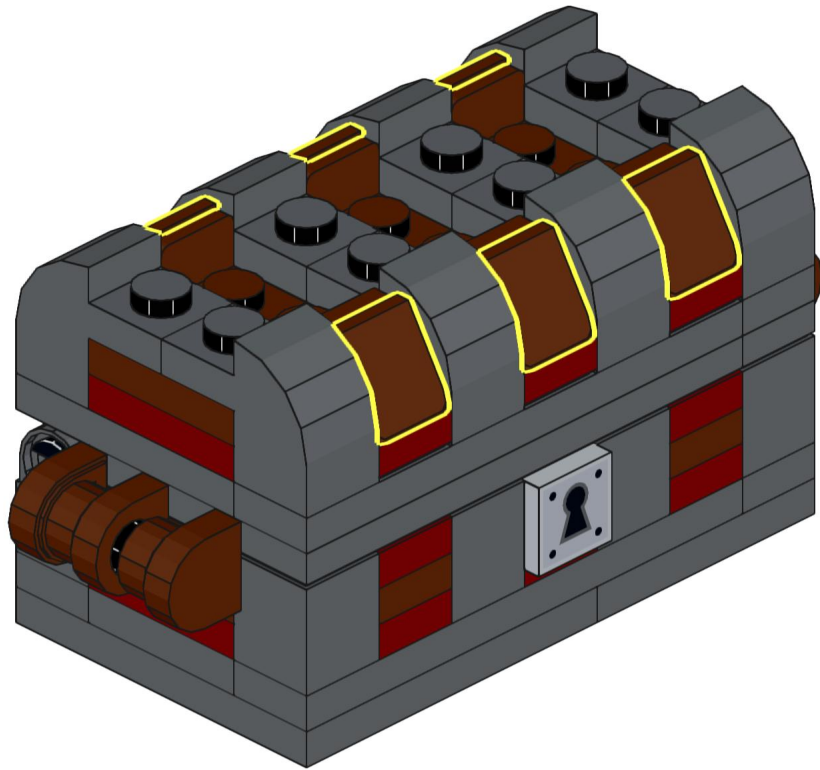

20

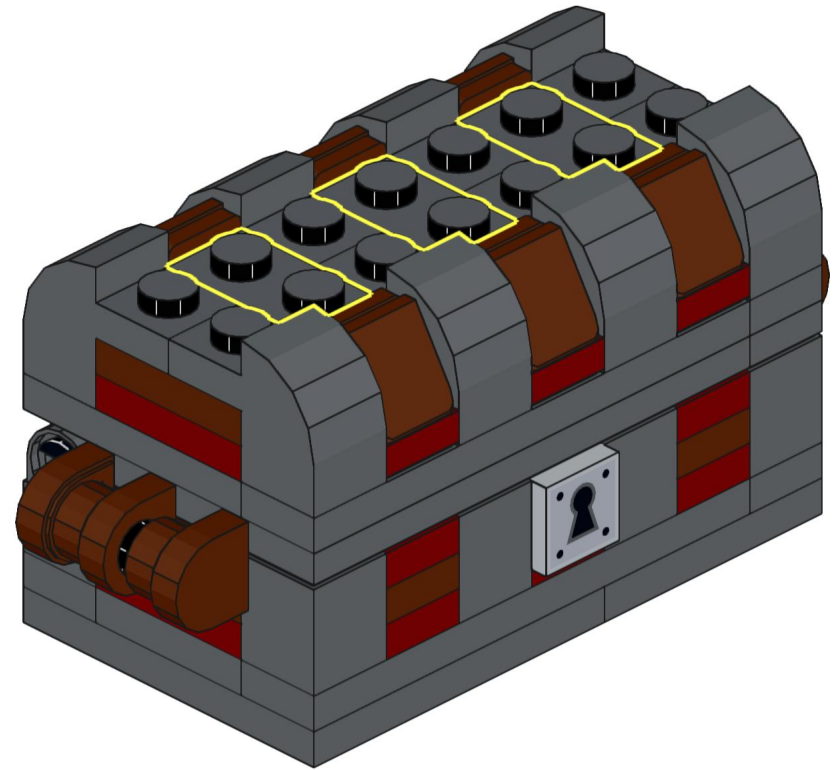
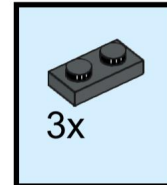

21

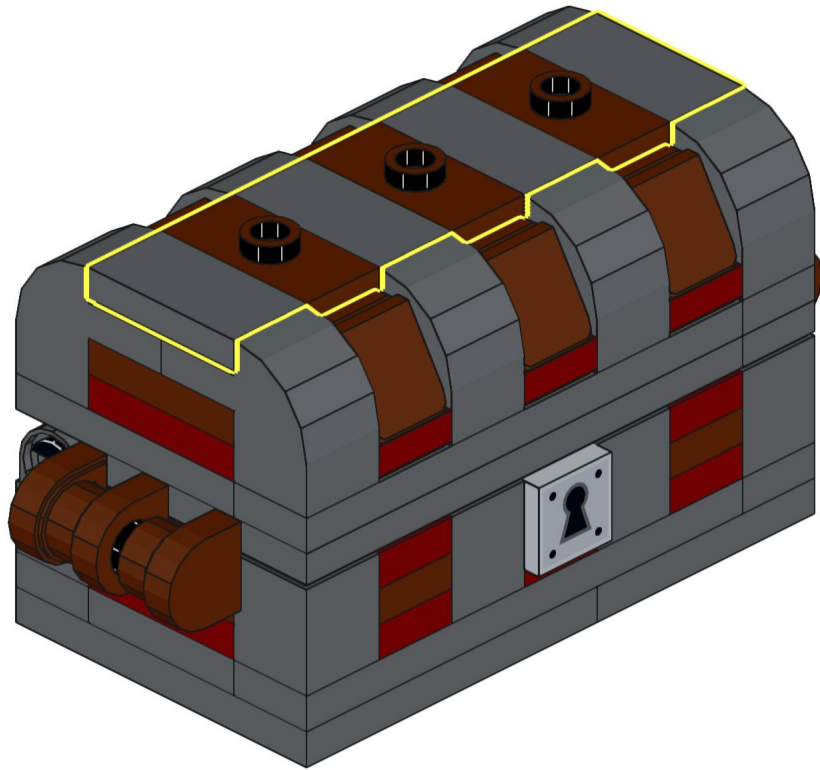
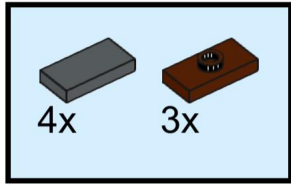

22

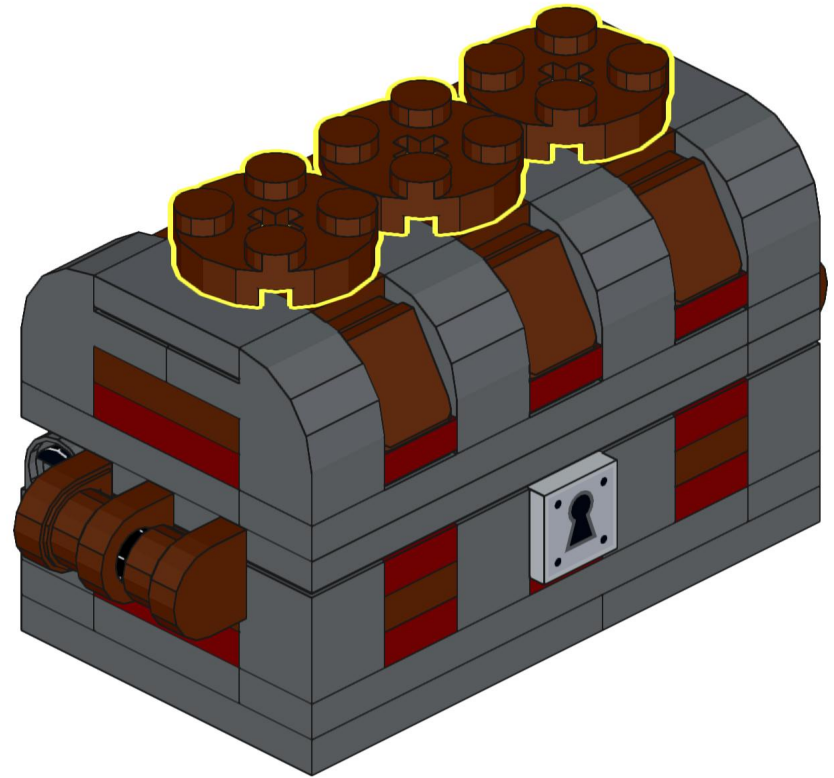

23

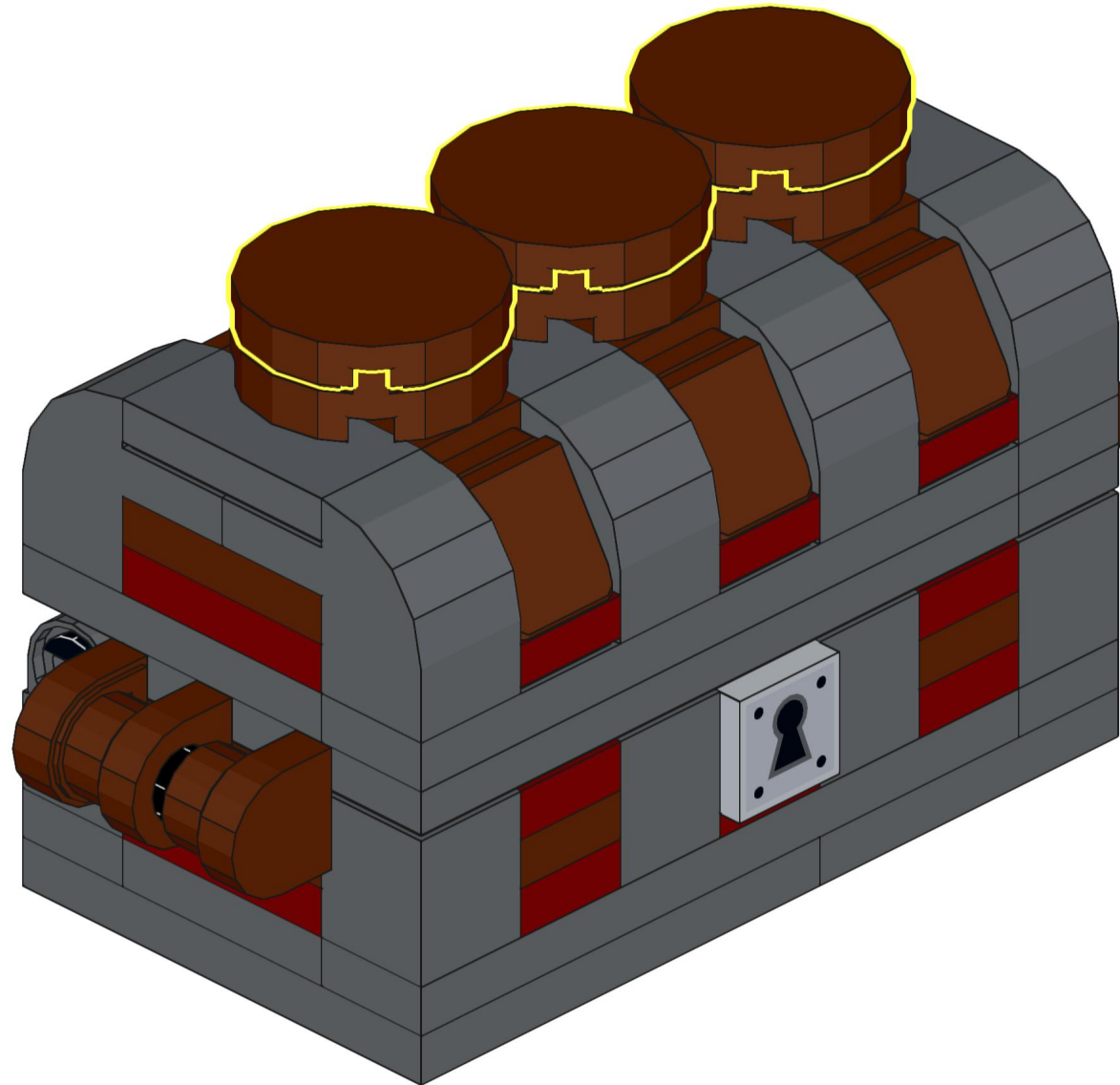
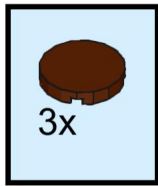



2x
bb1241
Black

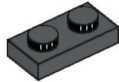

6x
3023
Dark Bluish Gray



2x
3021
Dark Bluish Gray



1x
3070pb081
Light Bluish Gray

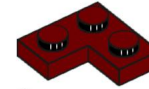

2x
2420
Dark Red



4x
4081b
Reddish Brown

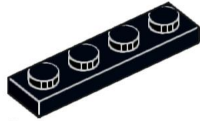

2x
3710
Black

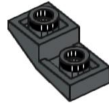

2x
24201
Dark Bluish Gray

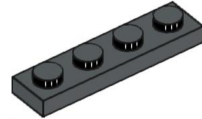

1x
3710
Dark Bluish Gray



6x
3070
Dark Red

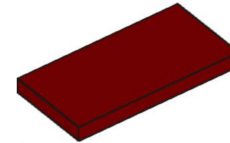

1x
87079
Dark Red

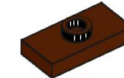

3x
15573
Reddish Brown



6x
3024
Dark Bluish Gray



2x
11458
Dark Bluish Gray

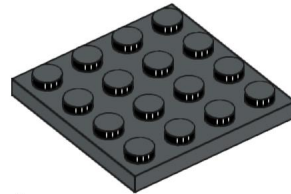

1x
3031
Dark Bluish Gray



5x
3024
Dark Red



6x
24246
Reddish Brown



4x
3023
Reddish Brown



2x
49307
Dark Bluish Gray



8x
6091
Dark Bluish Gray

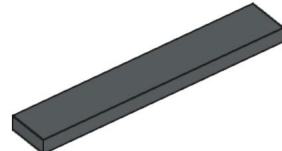

1x
6636
Dark Bluish Gray



2x
54200
Dark Red



5x
3024
Reddish Brown

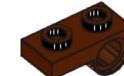

2x
18677
Reddish Brown



4x
3005
Dark Bluish Gray



2x
3623
Dark Bluish Gray

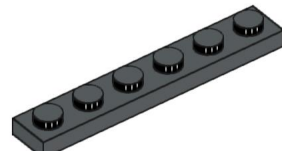

4x
3666
Dark Bluish Gray



1x
4070
Dark Red



6x
54200
Reddish Brown



3x
4032
Reddish Brown



5x
3069
Dark Bluish Gray

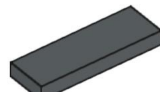

1x
63864
Dark Bluish Gray



1x
3069
Dark Red



1x
49307
Reddish Brown



3x
14769
Reddish Brown



2x
3023
Dark Red



6x
36840
Reddish Brown